

2021 PRODUCT CATALOGUE



CAMO
The Better Way to Build a Deck

BUILD YOUR DECK UP TO 5X FASTER

ANY DECK BOARD, SUBSTRUCTURE, DESIGN, OR DESIRED FINISH.
CAMO[®] HELPS YOU BUILD BETTER.



FASTENERS

UNIVERSAL CLIPS & SCREWS

Any fastening method for any board.



LEVER[®]

BOARD BENDING & LOCKING TOOL

Lock any board on wood or metal joists.



DRIVE[™]

STAND-UP DECK FASTENING TOOL









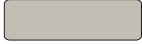

Fasten Edge Screws, Clips, and Face Screws.













CONTENTS

FASTENER & TOOL SELECTOR	4
DRIVE™ SYSTEM	6
COLLATED SCREWS	8
CLIPS	10
MARKSMAN SYSTEM	12
EDGE SCREWS	14
ACCESSORIES	16
DRIVE ACCESSORIES	16
MARKSMAN ACCESSORIES	17
LEVER®	18

FIND THE
RIGHT
CAMO[®]
FASTENER
BY STARTING
WITH YOUR
BOARDS

BOARD PROFILE	FASTENING METHOD	FASTENERS	
<p>SQUARE</p>  <p>GROOVED</p> 	<p>EDGE</p>  <p>CLIP</p>  <p>FACE</p> 	<p>EDGE</p>  <p>WOOD FACE</p> 	<p>UNIVERSAL DECK CLIPS</p>  <p>STARTER</p>  <p>EDGE*</p>  <p>EDGE*</p>  <p><small>ProTech is our premium ACO compatible coating</small></p>

			FASTENER	ALLOY / APPLICATION	
 Treated Pine (Wet)	Square	Edge	Collated Edge Screws	ProTech or Stainless Steel	
		Face	Edge Screws	ProTech or Stainless Steel	
			Collated Wood Face Screws	ProTech	
 Treated Pine (KDAT)	Square	Edge	Collated Edge Screws	ProTech or Stainless Steel with secondary 3/16 in. (4.7mm) spacer	
			Edge Screws	ProTech or Stainless Steel	
		Face	Collated Wood Face Screws	ProTech with secondary 3/16 in. (4.7mm) spacer	
 PVC & Composite (Uncapped)	Grooved	Clip	Universal Deck Clips	STARTER Clips for wood joists	
				EDGE 90° deck pattern on wood joists	
	Square	Edge		Collated Edge Screws	EDGE* Any deck pattern on wood joists
					ProTech or Stainless Steel with secondary 3/16 in. (4.7mm) spacer
 Composite (capped)	Grooved	Clip	Universal Deck Clips	STARTER Clips for wood joists	
				EDGE 90° deck pattern on wood joists	
				EDGE* Any deck pattern on wood joists	
	Square	Edge		Edge Screws	ProTech or Stainless Steel with pre-drilling
 Cedar & Redwood	Square	Edge	Edge Screws	Stainless Steel with secondary 3/16 in. (4.7mm) spacer	
			Collated Edge Screws	Stainless Steel with secondary 3/16 in. (4.7mm) spacer	
		Face	Collated Wood Face Screws	Stainless Steel with secondary 3/16 in. (4.7mm) spacer	
 Hardwood	Grooved	Clip	Universal Deck Clips	STARTER Clips for wood joists	
				EDGE 90° deck pattern on wood joists	
				EDGE* Any deck pattern on wood joists	
				EDGE*METAL Any deck pattern on 14-18ga metal joists	
	Square	Edge		Edge Screws	Stainless Steel with pre-drilling

TOOLS						
 NEVER-MISS™ Guide	 DRIVE™			 MARKSMAN Pro®	 MARKSMAN Pro®-NB	 LEVER®
Included with Universal Deck Clips	Edge	Clip	Face	Edge 3/16 in. Gap	Edge 3/16 in. Gap	Board Bending and Locking
	X					X
						X
			X			X
	X (Use secondary 3/16 in. (4.7mm spacers))					X
				X	X	X
			X (Use secondary 3/16 in. (4.7mm spacers))			X
						X
X		X				X
X		X				X
	X (Use secondary 3/16 in. (4.7mm spacers))					X
				X	X	X
						X
X		X				X
X		X				X
				X (Pre-drill)	X (Pre-drill)	X
	X (Use secondary 3/16 in. (4.7mm spacers))			X	X	X
	X (Use secondary 3/16 in. (4.7mm spacers))					X
			X (Use secondary 3/16 in. (4.7mm spacers))			X
						X
X		X				X
X		X				X
X		X				X
				X (Pre-drill)	X (Pre-drill)	X



DRIVE™

UNIVERSAL DECK FASTENING TOOL

Stand up, save your back and knees, and save your time with the award-winning CAMO® DRIVE™ system.

The DRIVE tool can be used to fasten almost any board* while comfortably standing up. DRIVE is for exclusive use with CAMO® Universal Deck Clips and CAMO® Collated Edge and Face Screws.

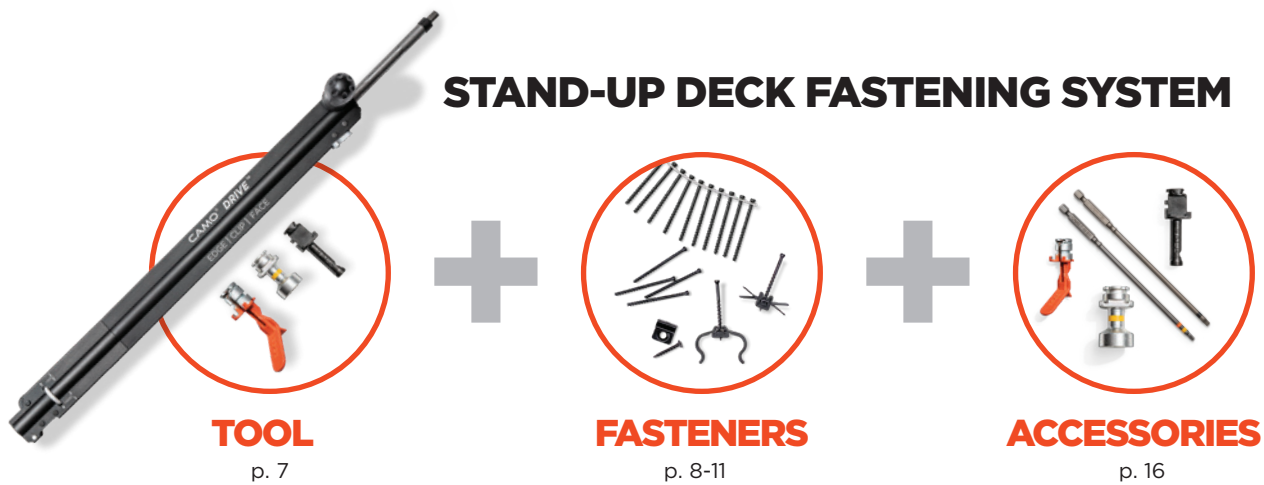

*We do not recommend using the DRIVE tool to Edge fasten capped composites or hardwood as these boards need to be pre-drilled. Instead, use the MARKSMAN Pro® Tool and Edge Screws (p. 15).



DRIVE™

- Install deck boards up to 5X faster with the cordless stand-up deck fastening tool that attaches to your drill
- Can be used for three fastening methods—Edge, Clip, and Face Fastening—on any deck board surface*
- Installs CAMO® proprietary fasteners: EDGE®, EDGEX® Clips, Collated Edge Screws, and Collated Face Screws
- Tool is easy to use—reversible handle for right or left-handed use, quickly swap out nose pieces, simple to load the bit
- Fastening while standing allows for fast installations that are easy on the body



SKU#	DESCRIPTION	QTY	CT./MASTER
345060	DRIVE	1	1

THREE WAYS TO FASTEN WITH DRIVE

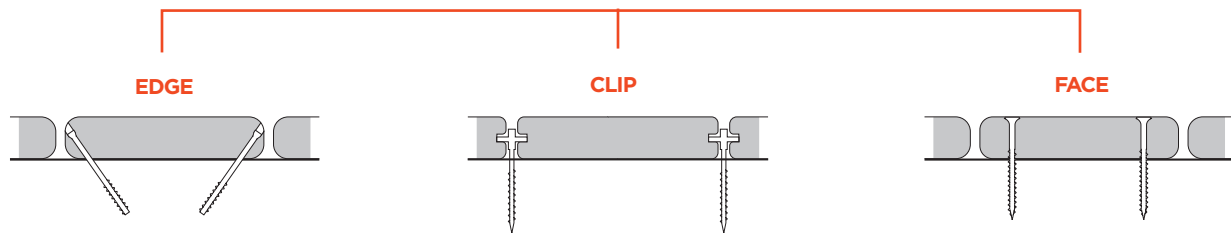

Use the Edge nose piece with CAMO® Collated Edge Screws (p. 8-9)

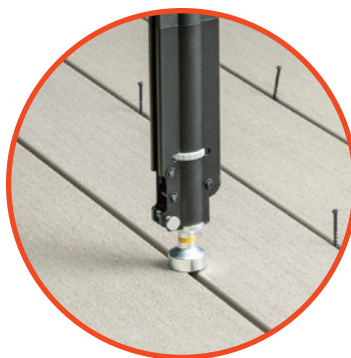

Use the Clip nose piece with CAMO® Universal Deck Clips (p. 10-11)



Use the Face nose piece with CAMO® Wood Face Screws (p. 8-9)



COLLATED SCREWS

CAMO® Collated screws are exclusively designed for use with the DRIVE tool.

Each fastener was intentionally created and collated for peak performance in its given application. Collated screws are available in 1000 ct. quantities, which cover 285 sq. ft. (26.48 M²) and come with their corresponding driver bits: T-15 for Edge Screws and T-20 for Wood Face Screws.



FOR EXCLUSIVE USE WITH DRIVE TOOL

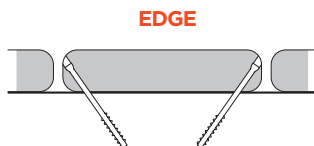

EDGE

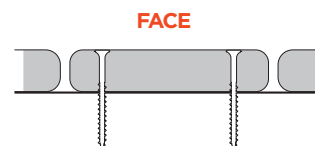

FACE

FOR USE WITH T-15 BIT + EDGE NOSE PIECE

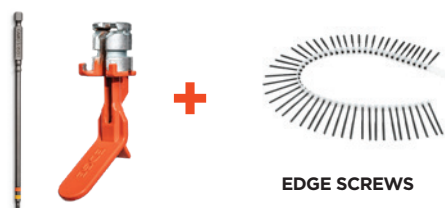

EDGE SCREWS

FOR USE WITH T-20 BIT + FACE NOSE PIECE

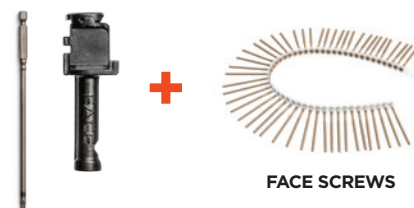

FACE SCREWS



COLLATED EDGE SCREWS

- For use with DRIVE and Edge nose piece (orange)
- 2-3/8 in. (60mm) screw secures 1-1-1/2 in. (26-38.1mm) thick pressure treated, cedar, redwood, composite, and PVC decking
- Rake tip augers material out reducing splitting and cracking, trimhead reduces visibility



SKU#	DESCRIPTION	ALLOY	SIZE	QTY	DRIVER BIT	CT/MASTER
395010	Collated Edge Screws for DRIVE	ProTech	2-3/8 in. (60mm)	1000	2 - T-15	1



COLLATED WOOD FACE SCREWS

- For use with DRIVE and Face nose piece (black)
- 3 in. (76mm) screw secures pressure treated, cedar, redwood, and hardwood boards up to 1-1/2 in. (38mm) thick
- Rake tip augers material out, reducing splitting, and buglehead draws the board tight



SKU#	DESCRIPTION	COLOR	SIZE	QTY	DRIVER BIT	CT/MASTER
395040	Collated Wood Face Screws for DRIVE - ProTech	Green	3 in. x #10 (76mm)	1000	2 - T-20	1



UNIVERSAL DECK CLIPS

CAMO® deck clips make installing grooved decking on wood or metal joists easy for everyone.

These hidden deck clips are designed and warranted for use with leading grooved decking and result in a beautiful fastener-free surface that you can install in half the time of other hidden fasteners. Fasten EDGE®, EDGEX® Clips by hand with the included NEVER-MISS™ Guide or standing up with DRIVE™.

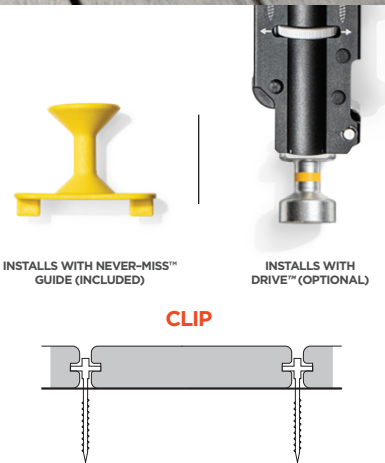



STARTER

- Secure the first and last board to achieve a completely fastener-free deck surface on wood joists
- Designed for use with leading grooved deck boards
- Screw tip bites into joist quickly
- Versatile clip can also be used as an L-bracket



SKU#	DESCRIPTION	COVERAGE	QTY	DRIVER BIT	CT./MASTER
0344087	STARTER Clip - For Wood Joists	30 LINEAL FT. (9M)	25	1 - T-15	6



EDGE®

- 90° deck patterns on wood joists
- One-pass fasteners—clip sits in place on the joist until you're ready to fasten
- Clip creates 3/16 in. (4.7mm) spacing
- Gusset holds boards down
- Fasten with included NEVER-MISS™ Guide or while standing up with the CAMO® DRIVE™



SKU#	DESCRIPTION	QTY	COVERAGE	DRIVER BIT	CT./MASTER
344354	EDGE Clip - 90° Deck Pattern on Wood Joists	90	50 SQ. FT. (4.64M ²)	1 - T-15	4
344359		450	250 SQ. FT. (23.22M ²)	2 - T-15	1



EDGEX®

- Any deck pattern on wood joists
- One-pass fasteners—clip sits in the groove of the board until you're ready to fasten
- Clip body creates 3/16 in. (4.7mm) spacing
- Gusset holds boards down
- Fasten with included NEVER-MISS™ Guide or while standing up with the CAMO® DRIVE™



SKU#	DESCRIPTION	QTY	COVERAGE	DRIVER BIT	CT./MASTER
344554	EDGEX Clip - Any Deck Pattern on Wood Joists	90	50 SQ. FT. (4.64M ²)	1 - T-15	4
344559		450	250 SQ. FT. (23.22M ²)	2 - T-15	1



MARKSMAN SYSTEM

Achieve a fastener-free surface on square decking with this easy and affordable hidden fastening system.

MARKSMAN Tools automatically establish spacing between boards and direct CAMO® Edge Screws into the edge of the board, leaving a smooth deck surface. Plus, the MARKSMAN System is backed by a CAMO® warranty for use in leading deck boards.

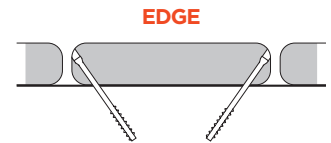

HIDDEN FASTENER SYSTEM



TOOLS

p. 13



FASTENERS

p. 14-15



ACCESSORIES

p. 16



MARKSMAN PRO®

- For use with CAMO® Edge Screws on square composite, PVC, capped composite, cedar, redwood, hardwood, and KDAT deck boards
- Fits most 5-¼ in. (133mm) to 5-¾ in. (146mm) boards
- Creates 3/16 in. (4.7mm) spacing



SKU#	DESCRIPTION	QTY	CT./MASTER
345001-AU	MARKSMAN Pro	1	6



MARKSMAN PRO® -NB

- For use with CAMO® Edge Screws on square composite, PVC, capped composite, cedar, redwood, hardwood, and KDAT narrow deck boards
- Fits most 3-¼ in. (83mm) to 5 in. (127mm) boards
- Creates 3/16 in. (4.7mm) spacing



SKU#	DESCRIPTION	QTY	CT./MASTER
345015-AU	MARKSMAN Pro - NB	1	6



EDGE SCREWS

The Best Deck Screws You'll Never See.

CAMO® Edge Screws are an innovative, easy-to-install hidden fastener that delivers a high-end look at an affordable price. They are for exclusive use with MARKSMAN tools. The Edge Screws feature a patented rake tip that augers material out as you drive to reduce board splitting and a trimhead to reduce visibility.

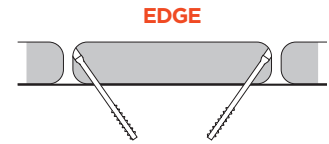

PROTECH



316 STAINLESS STEEL

DECK BOARD MATERIAL	RECOMMENDED CAMO® EDGE SCREW
Pressure Treated Pine	Stainless Steel or ProTech Coated
Composite	Stainless Steel or ProTech Coated
Capped Composite	Stainless Steel or ProTech Coated (with pre-drilling)
PVC	Stainless Steel or ProTech Coated
Cedar	Stainless Steel Required
Redwood	Stainless Steel Required
Hardwood or Imported Hardwood	Stainless Steel Required (with pre-drilling)

EDGE SCREWS

- For use with all square deck boards, including, treated pine, composite, PVC, capped composite, cedar, redwood, and hardwood
- Features a patented rake tip that augers material out as they're driven, reducing the potential for splitting and cracking*
- T-15 Star Drive offers best connection, reducing cam-outs and stripped screws
- Trimhead reduces visibility on the edge of the board
- Available in an ACQ Compatible ProTech coating and 316 Stainless Steel



*Pre-drilling is required for hardwood and capped composites

PROTECH COATED



SKU#	SIZE	QTY	COVERAGE	DRIVER BIT	CT./MASTER
345128-AU	1-7/8 in. (48mm) x #7	350	100 sq. ft. (9.29m ²)	1 - T-15	12
345124-AU		700	200 sq. ft. (18.58m ²)	2 - T-15	4
345119-AU		1750	500 sq. ft. (46.45m ²)	2 - T-15	4
345148-AU	2-3/8 in. (60mm) x #7	350	100 sq. ft. (9.29m ²)	1 - T-15	12
345144-AU		700	200 sq. ft. (18.58m ²)	2 - T-15	4

316 STAINLESS STEEL



SKU#	SIZE	QTY	COVERAGE	DRIVER BIT	CT./MASTER
345228S-AU	1-7/8 in. (48mm) x #7	350	100 sq. ft. (9.29m ²)	1 - T-15	12
345224S-AU		700	200 sq. ft. (18.58m ²)	2 - T-15	4
345219S-AU		1750	500 sq. ft. (46.45m ²)	2 - T-15	1
345244S-AU	2-3/8 in. (60mm) x #7	700	200 sq. ft. (18.58m ²)	2 - T-15	4

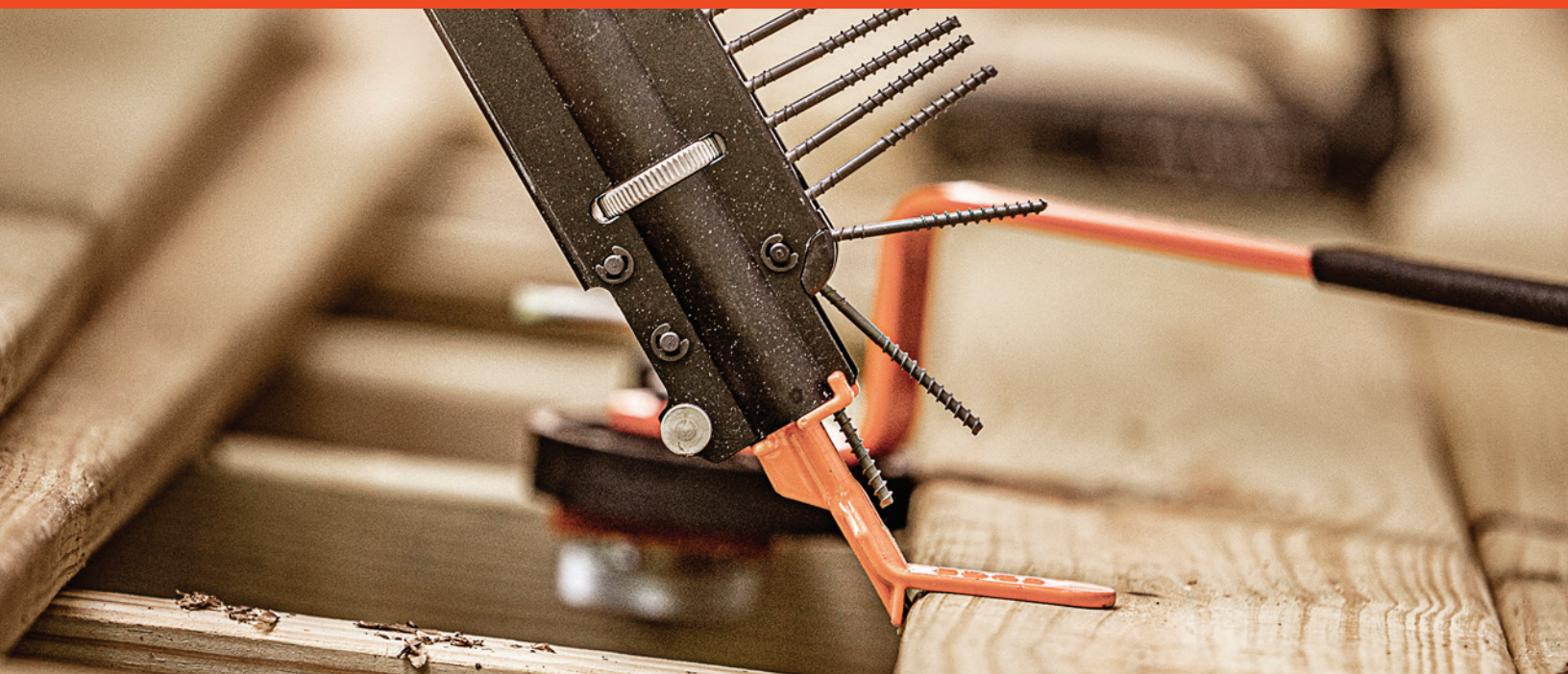

DRIVE ACCESSORIES

Driver bits are engineered specifically for use with the CAMO® DRIVE. The bits engage quickly and easily with the screw heads with reduced cam-outs, and are color-coded with a band for quick identification—orange and yellow for Edge and Clip fastening.

T-15 BIT



- For use with CAMO® DRIVE for Edge or Clip fastening
- 6.25 in. (160mm) long
- T-15 Star Drive



SKU#	DESCRIPTION	QTY	CT./MASTER
395715	T-15 Bit Replacement	2/pk	4



MARKSMAN ACCESSORIES

Driver Bits are engineered specifically for use with CAMO® Edge Screws and MARKSMAN Pro® tools. The built-in shoulder sets automatic depth of drive for maximum holding power, and prevents over-driving the screw.

DRIVER BITS SQUARE BOARDS



- For use with MARKSMAN Pro® tools and Edge Screws
- 3 in. (76mm) long
- T-15 Star Drive



SKU#	DESCRIPTION	QTY	CT./MASTER
345099-AU	Driver Bit	2/pk	10



LEVER®

BOARD BENDING AND LOCKING TOOL

Build a better deck by yourself with LEVER®, the one-turn tool that locks-in rows of boards and clips and straightens warped boards.



- Speeds up grooved deck installs—locks-in rows of boards and clips before fastening
- Strong enough to straighten any warped board
- Easily adjusts to wood and metal joists 1-½–3 in. (38-76mm) wide for jobsite versatility
- Multi-directional lever locks in one turn



SKU#	DESCRIPTION	QTY	CT./MASTER
345070	LEVER	1	4



LOCKS BOARDS & CLIPS

Use 2-4 LEVER tools across the length of the deck for the best clip installation experience with consistent spacing.

BENDS WARPED BOARDS

One LEVER is strong enough to straighten out warped pressure treated and hardwood boards in one turn.



ANY JOIST MATERIAL

Works on wood and metal joists



ANY JOIST WIDTH

Adjusts to joists 1-½ (38mm) to 3 in. (76mm) wide



ANY BOARD TYPE

Straightens and locks any board at any angle

ONE TOOL FOR EVERY JOB

CAMO[®]

The Better Way to Build a Deck

Distributed by



BROOKVALE, AUSTRALIA

13/42-46 Wattle Rd
Brookvale, NSW 2100

**FOR MORE INFORMATION, PLEASE VISIT WWW.CAMOFASTENERS.COM.AU OR
CALL 1300 721 738 TO SPEAK WITH A CAMO[®] PRODUCT EXPERT.**